



EFFICIENT POWER EP
MORE PRODUCTIVITY • LESS FUEL

CASE IH
AGRICULTURE

MAGNUM

273 - 389HP MAX. POWER – POWER MANAGEMENT
235 - 340HP RATED POWER

PAGE 4	PRODUCTIVITY
PAGE 8	ECONOMY
PAGE 12	SIMPLICITY
PAGE 16	COMFORT
PAGE 20	EXPERIENCE & QUALITY
PAGE 22	SPECIFICATIONS





POWER TO CHANGE THE INDUSTRY LANDSCAPE...

More food... more grain... more efficient emission standards... Case IH works with you to meet these demands, because at the ground level of the industry work needs to get done. The new style Magnum range is built to meet the power, durability, comfort and productivity needs of large-scale farmers, bringing reliable technology and value to their business.

Engine Power Management delivers up to an additional 37hp, giving up to 14% additional performance.

The hydraulic system gives you outstanding power and precise control, with up to 274 litres per minute flow capacity and up to 7,416kg lift capacity.

PRODUCTIVITY: PULLING POWER TO GET YOU THROUGH THE TOUGHEST CONDITIONS.

The Magnum range of engines are designed to deliver maximum horsepower with Efficient Power. Selective Catalytic Reduction (SCR) technology delivers the highest power needed with the lowest fuel consumption and emissions. Engine Power Management boosts power up to 37 more horsepower if needed, for navigating undulating fields, steep roads and meeting the higher PTO and hydraulic power demands of today's larger, more productive implements.

New front linkage with up to 5,000kg lift capacity and front PTO option.

Industry-best turning radius supplies you with precise, tight turns.



MORE POWER MEANS MORE PRODUCTIVITY.

Magnum common rail diesel engines are turbocharged, intercooled and designed to deliver maximum horsepower with enhanced efficiency. With powerful hydraulics, heavy-duty hitch and high-performance PTO, when you need to lift, lower, and power implements, Magnum will help you do more work.

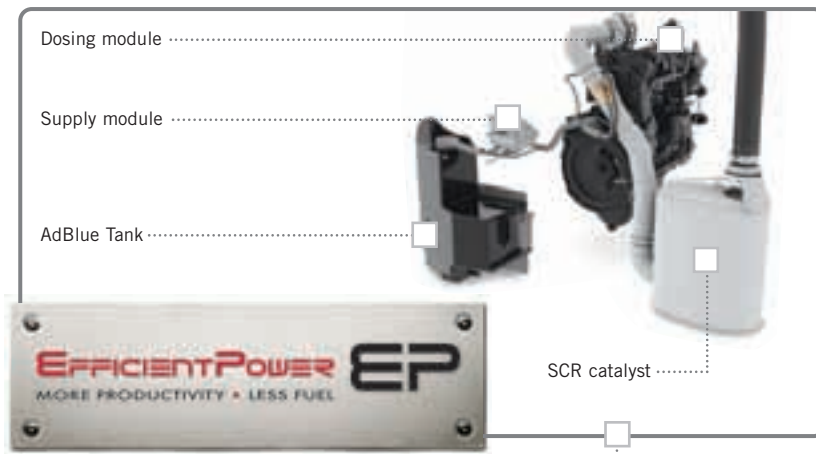

Case IH Selective Catalytic Reduction (SCR) technology

improves horsepower, engine responsiveness, fuel economy and engine reliability, all whilst lowering emissions. This makes SCR the superior solution for Magnum engines.



ENGINE.

Magnum engines are designed to deliver maximum horsepower smoothly and efficiently. Electronically controlled engines in Magnum tractors ensure peak power growth at low fuel consumption. If engine rpm drops under load, Engine Power Management unleashes up to 37 more horsepower. With that kind of power growth you have the boost you need to handle the most difficult terrain in the field and on the road.

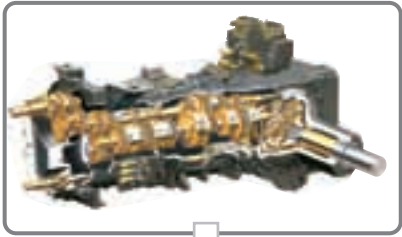

SOLID EFFICIENCY. AUTOSHIFTS.

For raw pulling efficiency, it's tough to beat the proven **Magnum full powershift transmission** with its integrated automatic shift. It provides seamless smooth shifting from start to 40 or 50kph. For slow-speed specialty situations, an optional shift through creeper transmission with 5 forward and 2 reverse speeds is available on all models.

HYDRAULICS + PTO.

Heavy-duty hitch and drawbar with standard electronic draft control provide up to 7,416kg lift capacity through the full range, giving you the versatility to move up to wider and heavier implements. Slip limit control with radar lets you adjust maximum slip according to your application, while Hitch Ride Control reduces bouncing during transport with mounted implements.

Advanced hydraulics system relies on a PFC (Pressure Flow Compensating) design with up to six electro-hydraulic remote valves. Six-function remote lever controls can be easily set from the driver's seat — orbital motor, loader, full function, no float and lock. Programmable valve timer lets you set

repeatable engagement times from the cab. A power beyond supply is also available for hydraulic power supply, return, load sense and case drain for easy hook-up to pull-type sprayers, for example. In addition a power beyond can be factory fitted giving you full control from the Multicontroller armrest.

1000 or 540/1000 speed PTO to handle whatever implement you're pulling. Magnum's PTO system is hydraulically activated and electronically controlled for smooth modulation and component protection. The PTO clutch is positioned on the top shaft for quieter operation. The PTO shaft can be rotated for easy coupling of implements.

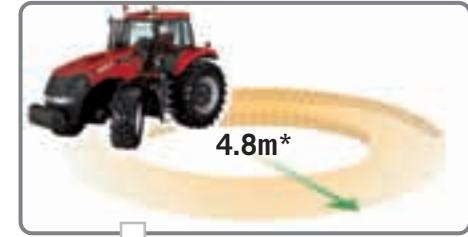

NO OTHER ROW CROP TRACTOR GIVES YOU A BETTER TURNING RADIUS.

The Magnum supplies you with precise, **tight turns** and a solid frame that delivers the strength you need to get optimum power to the ground.

*) 480/70R30 front tyres and 1829mm track setting

ECONOMY. TRACTORS BUILT NOT ONLY WITH FARMERS IN MIND, BUT WITH FARMERS AT OUR SIDE.

Case IH customers make our products more efficient and easier to use because they help us develop technology. Our engineers work with producers in the field then use that feedback to improve our designs. Case IH dealers and technicians engage those who use our products, get to learn how they work and find ways to improve results. It's how we've created solutions like APM (Automatic Productivity Management) and AFS (Advanced Farming Systems) to improve economy. Farming is changing and Magnum tractors are changing with it.

APM

APM (Automatic Productivity Management) optimizes efficiency while you concentrate on your work.

MAXIMUM UPTIME.

Keeping you working in your fields through longer service intervals of 600 h.



Advanced Farming Systems available on Magnum tractors are an essential ingredient for accuracy giving you improved efficiency.

ISOBUS implement interface, a powerful connection to integrate and control ISOBUS compatible implements with the tractor AFS Pro colour touch screen monitor.

STRAIGHT. IDENTICAL. REPEATABLE.

The optional AFS AccuGuide system is a simple but highly efficient auto-guidance solution.

COUNTING THE COST OF WORK DONE...

Throughout the new line-up of the Magnum range, improved fuel consumption reduces fuel inputs by up to 15%. The Case IH Efficient Power EP-technology benefits the farmer and the environment as it improves horsepower, engine responsiveness, fuel economy and engine reliability, all whilst lowering emissions.

In addition, running with minimal down time, extended service intervals with easy and effective routine servicing means more savings can be realised through years of improved productivity.

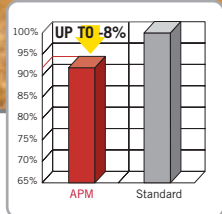

AUTO ROAD MODE.

Selecting the Auto Road function enables you to set the variable forward speed with the throttle lever, between 1.2kph and 40kph or 50kph depending on the transmission. The system automatically adjusts the engine speed and gear selection to give optimum fuel economy for the speed selected.

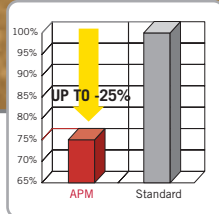

AUTO FIELD MODE.

Selecting the Auto Field function enables you to set a fixed field speed with the throttle lever. Field speed settings are up to 23kph and the operator no longer has to manually shift up or down or change engine speed to optimise work done by the tractor.

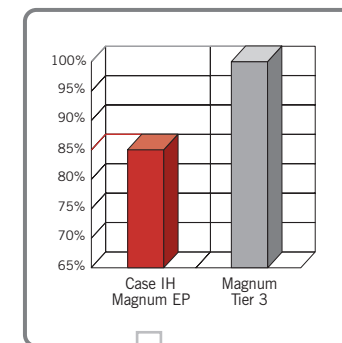

EFFICIENT POWER.

The SCR system provides up to 15% lower fuel consumption on Tier 4A SCR engines when compared to previous Tier 3 engines.

PRECISION COMPONENTS THAT MATCH THE WAY YOU FARM.

The AFS Pro 700™ touch screen monitor can be integrated into the armrest to provide a clear overview of vehicle settings, video inputs and simultaneous command and control of ISOBUS-compatible machinery.



AFS (ADVANCED FARMING SYSTEM) ENSURES UNRIVALLED PRECISION IN YOUR WORK.

Magnum tractors teamed with Case IH AFS Advanced Farming Systems provide the basis for fully automated precision farming with on the move yield mapping and auto-guidance steering, saving you time, money and effort year after year. **AccuGuide automatic steering systems** improve precision farming accuracy a step further by adding GPS controlled steering to your Advanced Farming Systems set-up.

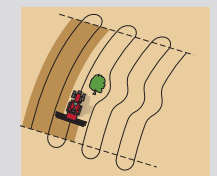
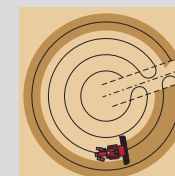
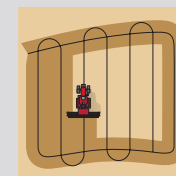

KEY FUNCTIONS ARE AT YOUR FINGERTIPS.

Multicontroller™ Drive Logic armrest featuring ICP™ intuitive control panel so key functions are at your fingertips.

At-a-glance status information provides the A-post mounted instrument cluster with integrated performance monitor.

SIMPLICITY SAVES YOU MONEY.

We relied on extensive input from producers to design the new Multicontroller armrest console in our Magnum tractors. All controls are close by and easy to use and it includes the largest touch screen in the industry, the AFS Pro 700. It's an operator control layout that helps you work through your fields in all conditions.

Get a clear picture with the **AFS Pro 700** touchscreen monitor.

HEADLAND MANAGEMENT CONTROL SAVES YOU TIME AND EFFORT.

This system can store up to 30 headland related operations and has a simple record and playback facility.



SIMPLICITY PUTS YOU IN THE LEAD.

Feedback from customers clearly indicates that tractors equipped with the Multicontroller and ICP (intuitive control panel) are the easiest to understand and operate. We have done the sums and found that, compared to competitors' systems, the Case IH control concept can save you nearly 30% on the time it takes to become fully acquainted with the way the tractor works.



A-POST INSTRUMENT DISPLAY.

The displays are clear, concise and easy to read. The optional **Integrated Performance Monitor** provides additional feedback on tractor systems status, percentage of slip, area worked, and service reminders. The driver is also alerted of any warnings, with the engine shutting down automatically to protect your investment if need be.



AFS ALREADY INSTALLED?

If you already employ Case IH Advanced Farming Systems on other tractors or combines using a portable AFS Pro 600 monitor, for example, **your existing screen(s) will be compatible with your new Magnum tractor.**





MULTICONTROLLER™ DRIVE LOGIC ARMREST.

The Multicontroller - featuring drive logic - and the ICP intuitive control panel plus AFS Pro 700™ touch screen monitor integrate **all the tractor's functions into the armrest.**

Here, you have all the functions you need in one place: speed selection, direction changes, throttle, Headland Management Control, electronic remote valves, rear hitch controls, PTO, joystick and much more. This operator-friendly environment gets even a novice driver working effectively on day one.

- | | |
|--|---|
| 1 Constant engine speed or Headland Management Control | 16 Auto PTO |
| 2 EHC linkage raise/lower | 17 Slip Control |
| 3 Remote valve control | 18 Headland Management Control |
| 4 Powershuttle | 19 Hitch Ride Control |
| 5 Gear ratio up shift or down shift | 20 AccuGuide (if equipped) |
| 6 AFS Pro 700™ touch screen monitor | 21 EHC Position Control |
| 7 Remote valve controls | 22 EHC Draft control |
| 8 Hydraulic motor mode and timer buttons | 23 EHC linkage raise/lower |
| 9 Joystick for remote valves | 24 PTO on/off |
| 10 ICP™ Intuitive Control Panel | 25 Slip Control |
| 11 Constant engine speed | 26 Encoder to adjust timer and flow control |
| 12 ECO Fan | 27 Linkage upper limit control |
| 13 Auto Field and Auto Road | 28 Linkage drop rate control |
| 14 Manual and Auto 4WD/Diff-Lock | 29 Draft sensitivity control |
| 15 Front axle suspension lock | 30 Front hitch management |

The image shows the interior of a Case IH tractor cab. A large red sign with white text is overlaid on the left side of the cab. The sign reads: "CASE IH TRACTORS AND COMBINES ARE KNOWN FOR THEIR COMFORT." Below this, it says: "Think about the highest standards of in-cab comfort available - and then be prepared for the Magnum Surveyor cab to exceed all your expectations. The quality of the leather upholstery and controls match the feeling of superior comfort once you are behind the wheel, looking forward to a full day's work. Put yourself in control, put yourself first." The background shows the cab's interior, including the steering wheel, a gear shifter, and a red leather seat. The view through the windows shows a green field under a blue sky.

CASE IH TRACTORS AND COMBINES ARE KNOWN FOR THEIR COMFORT.

Think about the highest standards of in-cab comfort available - and then be prepared for the Magnum Surveyor cab to exceed all your expectations. The quality of the leather upholstery and controls match the feeling of superior comfort once you are behind the wheel, looking forward to a full day's work. Put yourself in control, put yourself first.

360° visibility for clear sightlines in all directions.

Very **low noise levels** inside cab.

Luxury swivel seat for healthy posture.

Easy adjustments of steering wheel, seat and Multicontroller armrest to adopt the healthiest driving posture.

Smooth ride with optional **seat suspension, front suspension and cab suspension**.

Ideal working environment with **electronic climate control**.



TAKING THE STRAIN OUT OF A TOUGH JOB.

It's a tough job and it's a job that has to be done right now.

Good to know that your tractor is ready and waiting with the most comfortable cab in the business.

Luxury swivel seat with controls and monitor integrated into the Multicontroller armrest, which is adjustable in relation to your driving position. The armrest moves up and down and rotates with you if you turn the seat.

The steering wheel can be tilted and height adjusted to give you the ideal healthy posture at work.

Equipped with air suspension, the leather seat is also available with an integrated heating/cooling system.

COMFORT



FRONT SUSPENSION IMPROVES RIDE COMFORT AT THE SAME TIME AS PROVIDING MORE CONTROL.

Working together with the cab suspension, the **suspended beam ClassIV front axle** design for Magnum 235 - 315, **isolate the driver from shocks.** A suspended Class 5 axle and control system is available for the Magnum 340.



STAY RELAXED, STAY ALERT.

Automatic climate control lets you select the perfect temperature for continuous comfort.



LIGHTEN UP THE DARKEST NIGHT.

Take your pick of lighting packages including standard halogen along with optional High-Intensity-Discharge (HID) lighting technology. **For maximum illumination, opt for the 360° work lamp package** that includes 3 front HID lamps, 2 rear fender HIDs, plus 2 roof side-mounted halogens, as well as helpful egress lighting for exiting the tractor in the dark.

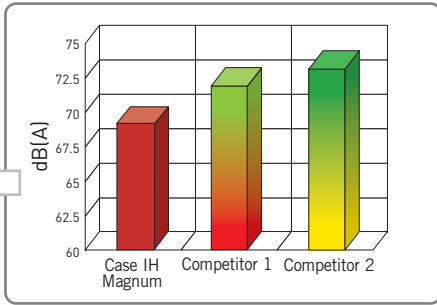

VERY LOW NOISE LEVELS INSIDE CAB.

At just 68dB(A) the cab is quieter than inside an average car.



EXPERIENCE AND QUALITY. SETTING THE STANDARD.

More than 115,000 Magnum tractors have been built at the Case IH plant in Racine/USA. From the finish of the paintwork to the core of the heavy-duty frame, these tractors are built to last and are delivered with the specifications you need to get your work done. Start right now and keep producing top productivity year after year.



CHOOSE THE TRACTOR WITH BUILT-IN EXPERIENCE AND QUALITY.

Equipment availability is critical in farming because when it's time to get going you need to know that you have every possible resource at your disposal. That is why it is important to choose a tractor that is backed by a heritage of quality, built in the USA: Case IH has been developing reliable agricultural machinery for more than 160 years and took the lead in pioneering Automatic Productivity Management well ahead of the rest of the field. More than **115,000 Magnum** tractors have been sold.



OUR DRIVERS WERE KEEN ON THE MAGNUM.

Can't imagine better accommodation on a tractor. Smooth powershift – all power to the wheels. **Tom Dye, Albanwise Farming Ltd, Holt, United Kingdom.**



RELIABILITY AND VALUE RETENTION.

Unbeatable quality and ruggedness, designed for the very highest performance. **Hubert Steiger (Farming association), Kirchdorf, Germany.**

MORE PEOPLE WORKING WITH YOU THAN ANYONE ELSE.

We send more than just our tractors out to work in your fields. Our dealers have the experience to help you find the equipment that maximizes yields and produces the efficient farming you demand. Case IH parts and service technicians have the expertise to assist you before, during and after the sale. CNH Capital will help you to examine and consider a variety of financing solutions to identify what works best for your needs and your farm. It's an integrated equipment, maximum service and financing system in one package - all of it focused on your operation.



KNOWLEDGEABLE DEALERS THAT WORK WITH YOU.

Your Case IH dealer understands you need an optimum return on your investment. That means getting the right Magnum horsepower and capabilities with the tools and implements that best fit your farm. Your dealer can recommend the appropriate options package, with proper tyres, weighting and ballast. Your Case IH dealer doesn't ask, "What do you want to buy today?" He or she will ask, "What do you want to do today?"



OFFERING FINANCING SOLUTIONS FOR MORE THAN 50 YEARS.

CNH Capital's extensive experience in the agricultural industry has created a deep understanding of your unique needs.

Competitive equipment financing with flexible payments can be timed to your cash flow. Alternatively, conserve capital and reduce upfront payments with operating and finance leases. For other needs choose from credit cards specific to the agricultural industry. We can even help you finance crop-input products or land rental. There are financing options that fit the way you farm. CNH Capital helps you find them.



ALL THE PARTS AND SERVICE TO KEEP YOUR EQUIPMENT RUNNING.

Find the **full line of Case IH parts** and components at your local dealer. Plus full-service maintenance programmes and industry-leading warranties. It's expertise applied by skilled, factory-trained service professionals committed to providing you maximum uptime, season after season.



MAX - THE NEW PREMIUM SERVICE FROM CASE IH.

We are always ready for you, around the clock, the whole year. Express delivery when and where you need it. You get top priority during the season because your harvest cannot wait. The call is free, however some European Operators may apply a charge if the call is made from a mobile phone. For any information about charge rate, please enquire in advance from your provider.

Extended protection programme. Case IH is at your side giving you the best professional solution: Safeguard from Covéa Fleet. This is the personalised insurance coverage for your Case IH machinery. Please contact your dealer for more details. Subject to status and availability. Terms and conditions apply.



MODELS	MAGNUM 235	MAGNUM 260	MAGNUM 290 Efficient Power EP	MAGNUM 315	MAGNUM 340
ENGINE					
Number of cylinders / type / emission level	6 / Common Rail Diesel engine with 24 valves, turbocharged and intercooled / Tier4a				
Capacity (cm ³)	8700	8700	8700	8700	8700
Rated power ECE R120 ³⁾ (kW/hp(CV))	173 / 235	189 / 257	209 / 284	229 / 311	250 / 340
Rated power ECE R120 ³⁾ Power Management (kW/hp(CV))	199 / 271	216 / 294	235 / 320	255 / 347	276 / 375
Rated engine speed (rpm)	2000	2000	2000	2000	2000
Maximum power ECE R120 ³⁾ (kW/hp(CV))	197 / 268	213 / 290	233 / 317	255 / 347	275 / 374
Maximum power ECE R120 ³⁾ Power Management (kW/hp(CV))	201 / 273	219 / 298	241 / 328	263 / 358	286 / 389
... at engine speed (rpm)	1800	1800	1800	1800	1800
Maximum torque (Nm/rpm)	593 / 1400	643 / 1400	690 / 1400	593 / 1400	643 / 1400
Maximum torque - Power Management (Nm/rpm)	620 / 1600	678 / 1600	748 / 1600	620 / 1600	678 / 1600
Torque rise Standard / Power Management (%)	47 / 28	42 / 27	37 / 28	47 / 28	42 / 27
Fuel tank, diesel/urea (litres)	651 / 89.4	651 / 89.4	651 / 89.4	651 / 89.4	651 / 89.4
TRANSMISSION					
Type	Full Powershift with Powershuttle				
Number of standard speeds 50kph ^{*)}	19 x 4	19 x 4	19 x 4	19 x 4	19 x 4
Number of standard speeds Creeper 40kph	23 x 6	23 x 6	23 x 6	23 x 6	23 x 6
Differential lock rear axle	Multi-plate with automatic functions				
FOUR-WHEEL DRIVE AND STEERING					
Type	Differential lock as standard, front axle suspension optional				
Front axle suspension	o	o	o	o	o
Steering angle (°)	55	55	55	56	56
Min. turning radius ¹⁾ track setting 1829mm (m)	4.8	5.3	5.3	5.3	5.3
POWER TAKE OFF					
Type	Electro-hydraulic with Auto PTO control available				
Speeds Standard / Option	1000 / 540/1000	1000 / 540/1000	1000 / 540/1000	1000 / 540/1000	1000 / 540/1000
Engine speeds Standard / Option (rpm)	1800 / 1400/1800	1800 / 1400/1800	1800 / 1400/1800	1800 / 1400/1800	1800 / 1400/1800
Shaft type Standard PTO	1 3/4" 20 splines	1 3/4" 20 splines	1 3/4" 20 splines	1 3/4" 20 splines	1 3/4" 20 splines
Shaft type Optional PTO	1 3/4" 20 splines (1000rpm) or 1 3/8" 21 splines (1000rpm) or 1 3/8" 6 splines (540rpm)				
Front PTO with 1000rpm	o	o	o	o	o
HYDRAULIC SYSTEM					
System type	Variable displacement, pressure flow compensated pump				
Max. pump flow rate Standard / High Flow / Twin Flow (l/min)	161 / 218 / 161+113	161 / 218 / 161+113	161 / 218 / 161+113	161 / 218 / 161+113	161 / 218 / 161+113
System pressure (bar)	210	210	210	210	210
Control type	Electronic Hitch Control (EHC) with cushion ride control, hydraulic top link, automatic stabilizers optional				
Max. lift capacity (kg)	8550	9130	9130	10200	10200
OECD lift capacity through range @ 610mm (kg)	6337	6706	6706	7416	7416
Max. number of remote valves	4 standard, 5th and 6h remote optional; power beyond or low pressure return connection with individual remote valve timer and flow controls when equipped with Performance Monitor				
Remote valve timer control	0 - 30 seconds on all models				
Category type	Cat III / IVN	Cat III / IVN	Cat III / IVN	Cat III / IVN	Cat III / IVN
Slip control	●	●	●	●	●
Front hitch with 5000kg lift capacity	o	o	o	o	o

MODELS	MAGNUM 235	MAGNUM 260	MAGNUM 290 Efficient Power EP	MAGNUM 315	MAGNUM 340
WEIGHT					
Minimum shipping weight (kg)	9136	9136	9377	9377	9568
Permissible total weight Standard / Class V front axle (kg) (kg)	17500 / -	17500 / -	17500 / 18000	17500 / 18000	- / 18000
Max. permissible weight front Standard / Option (kg)	6030 / -	6030 / -	6030 / 6750	6030 / 6750	- / 6750
Max. permissible weight rear Standard / Option (kg)	11500 / -	11500 / -	11500 / 11500	11500 / 11500	- / 11500
DIMENSIONS ¹⁾					
A: Total length (mm)	6428	6428	6428	6428	6428
B: Total height (mm)	3378	3378	3378	3378	3378
C: Total width (across rear fenders with 150mm extension) (mm)	2550	2550	2550	2550	2550
D: Wheel base (mm)	3055	3055	3055	3055	3055
E: Height at centre of rear axle, highest point (mm)	2488	2488	2488	2488	2488
F: Track setting front (mm)	1560-2256	1560-2256	1560-2256	1560-2256	1560-2256
rear (mm)	1470-2294	1470-2294	1470-2294	1470-2294	1470-2294
STANDARD TYRES ²⁾					
Front	600/65 R28	600/70 R30	600/70 R30	600/70 R30	600/70 R30
Rear	620/70 R42	710/70 R42	710/70 R42	710/70 R42	710/70 R42

● Standard Equipment ○ Optional Equipment - Not available ¹⁾ With standard tyres ²⁾ Other tyres on request ³⁾ ECE R120 correspond to ISO 14396 and 97/68/EC

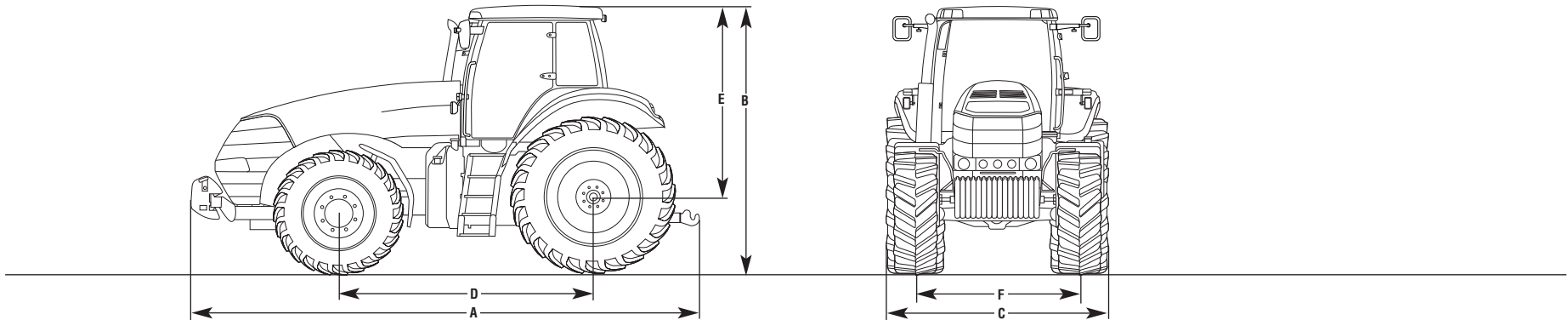



WWW.CASEIH.COM



Safety never hurts! Always read the Operator's Manual before working with any equipment. Inspect equipment before using it, and be sure it is operating properly. Follow the product safety signs, and use any safety features provided.

This literature has been published for worldwide circulation. The standard and optional equipment and the availability of individual models may vary from one country to the next. Case IH reserves the right to undertake modifications without prior notice to the design and technical equipment at all times without this resulting in any obligation whatsoever to make such modifications to units already sold. Whilst every effort is made to ensure that the specifications, descriptions and illustrations in this brochure are correct at the time of going to press, these are also subject to change without prior notice. Illustrations may show optional equipment or may not show all standard equipment.

Case IH recommends **AKCELA**™ lubricants

CNH UK Ltd., Cranes Farm Road, Basildon, Essex SS14 3AD - © 2011 CASE IH - www.caseih.com - MAGNUM-UK-BR - Free phone 00800 22 73 44 00 - Printed in Italy - 01/11 - TP01 - Cod. 10C0005/1NB